

---

Electric Water Purifier  
WATER  
PURIFIER

---

User Manual

---

CP-ABN100GP  
CP-ABN100GW

---

# CUCKOO



# CUCKOO

## Dear customers!

Thank you very much for using the CUCKOO Electric Water Purifier.

Please retain this manual (including the Warranty) for future reference.

This manual will be of great help should you have any questions or if the functions do not work properly.



## Features and Benefits of CUCKOO Electric Water Purifier

### Product Benefits

- **Nano Positive Filtering System**  
Application of CUCKOO Electric Water Purifier's Nano Positive Filtering System produces clean and healthy water containing minerals.
- **Healthy electric water purifier**  
You may drink water, which has passed a filter in an instantaneous cooling, heating or purification method, as cold, hot or room temperature water.
- **Water purifier featuring an ultraslim design and Multiple functions**  
Cold water, hot water, room temperature water and Sterilization(Cleaning) Water are available in a single water purifier and, thanks to its slim and classy design, spaces can be used in a more efficient manner.
- **Electrolytic Sterilization(Cleaning) System**  
An Electrolytic Sterilization(Cleaning) System is applied to enable sanitary use of the water purifier, and Sterilization(Cleaning) Water is dispensed as the sink faucet to utilize it to clean food ingredients and kitchenware.
- **Economical and Eco-Friendly Water Filtration System**  
An extremely economical and eco-friendly water purification system, which produces no wasted water in the process of water filtration through a Nano Positive Filter, has been selected.
- **Button Lock/Functional Lock**  
To prevent potential accidents as a result of product misuse by children or the elderly, Button Lock and Functional Lock (hot water, Sterilization(Cleaning) Water) have been added.
- **Water Leak Prevention System**  
Water leakage that may be caused during product usage is detected and prevented to enable safe use of the water purifier.
- **Non-stop Dispensing Function**  
You can continuously dispense cold water, hot water, and room temperature water.
- **Fixed Quantity Dispensing Function**  
It is convenient to be able to dispense a fixed quantity, either One Cup (about 250cc) or Half Cup (about 120cc), of cold water, hot water or room temperature water.

This manual includes the warranty.

Before using the product, make sure to read the "User Manual" to use it accurately. After reading it, please keep it in a place where people who use the product can access it anytime.

**Caution:** This product is for household use, and other uses (industrial, experimental, etc.) are prohibited. In order to use this product for a long time without malfunctioning, please read this User Manual.



---

## CONTENTS

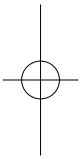
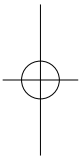

<b>Before Use</b>	● Features and Benefits of CUCKOO Electric Water Purifier	2
	Warnings for Safe Use	4 ~ 7
	Cautions for Safe Use	8 ~ 9
	Part Names and Accessories	10 ~ 11
<b>During Use</b>	● Filtration System	12
	How to Install the Product	13
	Use the Checklist Before Use	14
	How To Use	15 ~ 27
	How To Clean Tray / How To Clean Main Body	28
	How To Replace the Filters	29 ~ 30
	Expected Filter Replacement Cycle / Recommendations / Filter Arrangement	31
<b>Before Asking for Support</b>	● Please check before asking for support.	32 ~ 33
<b>Service Guide</b>	● Product Specifications	34

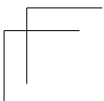
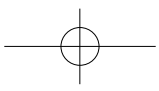
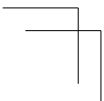



## Warnings for Safe Use

- Please comply with the "Safety Warnings" to ensure safe and proper use of the product and to avoid accidents or dangerous situations.
- The "Warnings for Safe Use" section consists of "Warning" and "Caution" items, which are defined as follows.

<p><b>Warning</b></p> <p>Potentially dangerous situations that can cause serious injuries or death if not avoided.</p>	<p> This symbol indicates a potentially dangerous situation under specific circumstances.</p> <p>• Please read the details carefully and follow the instructions to avoid dangerous situations.</p>
<p><b>Caution</b></p> <p>Potentially dangerous situation that can cause minor injuries if not avoided.</p>	<p> This symbol is used to indicate actions that are prohibited.</p> <p> This symbol is used to indicate 'instructed' actions.</p>

### About Power

**Warning**    **Prohibited**

Make sure to use it on an outlet exclusively for 220V -240V and the current rating of 13A or greater that can be grounded, and do not insert power plugs of several products in a single outlet at the same time.

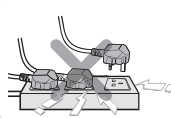

- If you use it with a lot of products, this may cause a fire or an electric shock. Please check the power outlet regularly.
- If it is not properly grounded, this may cause electric shock due to a short circuit.
- If there is a foreign substance or moisture on the Power Plug, wipe it thoroughly before use.

If a Power Cord or a Power Plug is damaged or when the Power Outlet is shaky, stop using the product and contact our Customer Service Center.



- If the sheath of the power cord is peeled off or severed during use of the product due to negligence, it may cause fire or electric shock. Thus, please frequently check the condition of the power cord, power plug and power outlet.
- To prevent dangerous situations arising from the damage of the power cord or the power plug, please contact the manufacturer, distributor or certified technician (service staff) for replacement of the cord.
- We strongly recommend that the damaged parts be repaired at a designated service center.
- This may cause electric shock, short circuit, and fire.

Do not bend, tie or pull the Power Cord by force. Do not plug in multiple devices into the same power outlet or extension cord simultaneously.

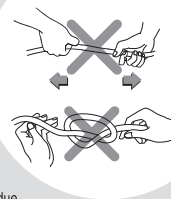

- This may cause electric shock or fire due to a short circuit.

If there is any moisture, dust, or foreign substances on the Power Plug, remove them with a dry cloth.



- This may cause electric shock or fire. Please check the Power Plug frequently.

Do not use an attachable multi-power outlet.

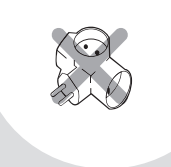

- This may cause a fire or electric shock.

If you use a movable extension cord, use only a single product for an extension cord of 13A of current capacity and ensure that it is properly grounded.

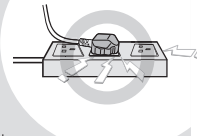

- This may cause a fire or electric shock.

## Warnings for Safe Use



### About Power

**Warning**

**Prohibited**

When unplugging the product, make sure to hold the Power Plug, not the Power Cord.

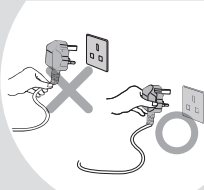

- Applying force to the Power Cord may cause electric shock or fire. Please check the Power Plug and the Power Cord frequently.

Use alternating current voltage of 220V-240V only.

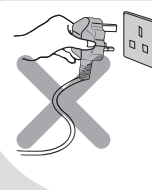

- This may cause electric shock and/or fire.
- The product will not work properly.
- Please check the Power Plug and the Power Cord frequently.

During water leakage or cleaning, make sure to close the Tap Water Supply Valve and pull out the plug.

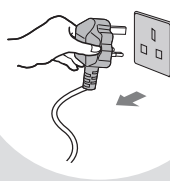

- There is a risk of electric shock or malfunction. Please check the Power Plug and the Power Cord frequently.

When inserting or pulling out the Power Plug to and from the Power Outlet, first remove any moisture on your hands and then put in or pull out the Power Plug when holding it.

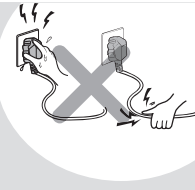

- Pulling out the Power Plug with wet hands can cause electric shock.
- Pulling the power cord by excessive force can damage the Power Cord, causing a short circuit or electric shock. Please check the Power Plug and the Power Cord frequently.

Make sure the Power Cord is not under a heavy object or near sharp objects. Take special caution to ensure that it is not easily damaged by your pet.

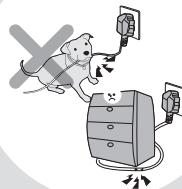

- If you do not do so, this may cause damage to the cord, leading to electric shock or fire. Please check the Power Cord frequently.

When you do not intend to use the product for a long time, Close the valve, empty out the refrigerant tank and pull out the power plug.

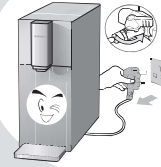

- Before reuse, fill it with water and then empty it out or run the Immediate Sterilization (Cleaning) function.
- Before reuse, refer to the "Checklist Before Use" (Page 14)

Please also unplug the product before inspection, repair or replacement of its parts.

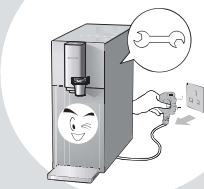

- There is a risk of malfunction or electric shock. Please check the Power Plug and the Power Cord frequently.

If water enters the power supply area, unplug the product and dry it completely before use.



- This may cause electric shock or fire. Please check the Power Plug and the Power Cord frequently.

ENG



## Warnings for Safe Use

### About Installation

**Warning**

**Prohibited**

Do not install where it may be exposed to moisture, excessive dust, and splashing water.

- Install the product in a clean environment.
- This may cause a malfunction, electric shock or fire.



Do not install the product in a place from which gas may be leaked or where an air conditioner or a heater is located.

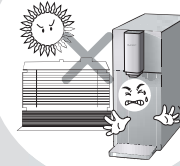

- There is a risk of explosion or fire.

Do not install the product near the bathroom.

Do not install the product on an uneven surface or a slope, or on a pad, cushion, blanket or carpet.

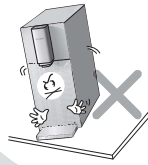

- This may cause malfunction, unwanted noise or injury. Please check the product regularly if it is working properly.
- This may cause product damage and fire.

Always use the water supply for tap water, and install the Tap Water Supply Valve near the Cooling Water Pipe.



- Do not use water sources other than tap water, such as groundwater.
- Filter change cycles can vary according to the region and capacity of water use.
- Installing it in a hot water pipe may cause damage to the filter and/or product.

Avoid direct sunlight and high temperatures.

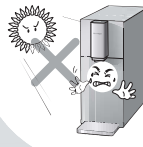

- This may cause color changes or discoloration.
- Please check the Power Cord frequently.

Avoid installing a product outdoors or in a place where the surrounding temperature drops below 5°C.



- This may cause the filter, tubing or any other components to freeze, causing malfunction of the product.
- The temperature of the environment for using the product is 5-40°C.

Make sure that the length of the Tap Water Supply Tube doesn't exceed 5 m from the Tap Water Supply Valve.

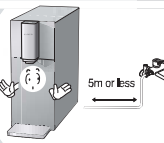

- If you do not do so, it may cause poor performance of the product.

Do not lift the drain hose, which is connected to the product, over the surface where the product is installed, and do not connect it to the water purifier over a distance of 3m or greater.

- The drainage function may not work smoothly.

Secure at least 20cm from walls and install the product on a solid and flat surface.

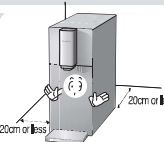

- If you do not do so, it may cause poor performance of the product.

When connecting the drain hose to the drain while letting the hose touch the floor of the kitchen, etc., do not lift it 30cm or higher from the floor.

- The drainage function may not work smoothly.

## Warnings for Safe Use



### During Use

#### Warning

#### Prohibited

Do not use the product by placing an electric heating appliance such as a microwave, electric oven and toaster on top of it, or place an inflammable substance such as a candle, gas container and/or lighter on the product.

- There is a risk of fire, electric shock or accidents.

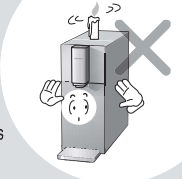

Do not place chemicals, water bottles or small metal materials on top of the product.

- If any of it gets into the product, there is a risk of fire and/or damage to the product.



When moving the product, do not pull the power cord and connection hose or grab the outlet area.

- This may cause damage to the product.



Do not disassemble or remodel the product.

- This may cause fire and/or electric shock.
- Do not allow anyone other than authorized service providers to disassemble or repair the product.

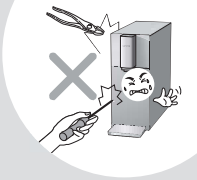

This device is not made to be used by persons (including children) who are unable to use it safely without supervision or guidance for lacking the bodily, sensory and/or mental capacity or the experience and knowledge.

- Make sure to educate and control children to prevent them from playing with the device.
- This may cause electric shock or injury.



- ※ Sterilization(Cleaning) water is not for drinking. Prevent anyone from drinking the Sterilization(Cleaning) water.
- ※ Use Sterilization(Cleaning) water to Clean fruits, vegetables and utensils, which are to be cleaned with a sink faucet.
- ※ After Sterilization(Cleaning) water is dispensed, the water still remains in the sink faucet valve so, after using the Sterilization(Cleaning) water, let the water (sink faucet) flow for about 3 seconds.

#### Warning

#### Instructions

If water leaks from the inside of a product or forms a puddle in the surroundings, close the Tap Water Supply Valve, turn off the Power button, pull out the power plug and contact our Customer Service Center.

- There is a risk of electric shock.

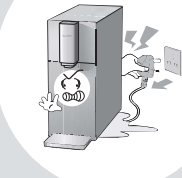

If you smell burning or see smoke arising from the product, unplug it immediately and close the Tap Water Supply Valve. After that, please contact our Customer Service Center.

- This may cause a fire.

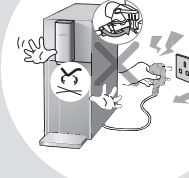

Be careful when using high-temperature water or hot water.

- Hot water (high-temperature water) may be splashed so make sure it does not come into contact with the body. (Be careful, especially, when the elderly or children use the product.)
- After stopping or terminating the dispensing of hot water (high-temperature water), some water may drip from the inside of the outlet so take out the cup after confirming it.

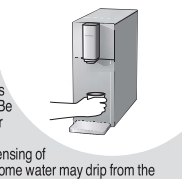

The product should be installed and removed by our service technicians through the Customer Service Center.

Pay attention to children or anyone not to control the Control Panel too often.

- This may cause damage to the product and/or a safety-related accident.

When replacing the filter, close the Tap Water Supply Valve (adapter). (The Tap Water Supply Valve is typically located below the sink or at the faucet.)

- This may cause a water leak.

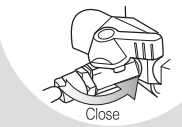

Prevent an air intake hole, air discharge hole, and gaps from being blocked or having foreign substances stuck inside such as a needle, cleaning pin, and metals.

- If you do not do so, this may cause an electric shock or fire.

Scrubbing the External Valve with a brush or a dishwashing sponge may damage the plating and, also, cause minerals to become stuck on it.



## Cautions for Safe Use

### ⚠ Caution

### 🚫 Instructions

Make sure the Cooling Water Tank Cover inside the product and the Top Cover are completely closed before use.

- It's also to keep foreign material away.



Replace the filters according to the replacement cycle.

- If you do not do so, This may cause poor filter performance or bad odor.
- Regarding the filter replacement cycle, refer to Page 31.

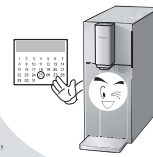

If the product has not been used for a long period of time, perform the Immediate Auto Sterilization(Cleaning) function once before use.

- Use the Immediate Sterilization(Cleaning) function to be able to easily clean the pipes and refrigerant tank (refer to Page 21).



When gas or propane leaks, do not pull out the Power Cord of the product but immediately open the windows to ventilate.

- This may cause a fire or electric shock.

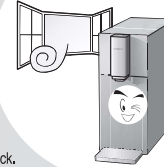

Do not use water from the purifier for a fishbowl or fish tank.

- The room temperature water may not be suitable for breeding fish. Depending on the circumstances, fish may die.

If you have not used the Sink Faucet for more than a day, it can be polluted. When reusing the sink faucet, let the water flow for about 1 to 2 minutes before use.

Must not use NON-Cuckoo Water Purifier filters.

- Use of a non-genuine filter other than a genuine CUCKOO filter may deteriorate the water purification performance, strange taste of the water, leakage and/or damage to the product.

Do not lean the product at a 30-degree angle or more when moving the product.

- This may cause poor performance of the product.

### ⚠ Caution

### 🚫 Prohibited

Do not clean the product using benzene or thinner.

- There is a risk of damage to the product.



Do not move the product while it is in operation.

- Do not move or shake the product when it's turned on. It may cause the connecting tube to be separated, leading to a malfunction of the product and water leak.

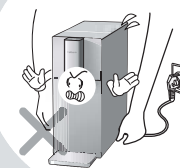

During use of the product, do not pull the hose on the back of the product.

- This may cause damage to the product due to water leakage.

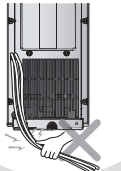



## Cautions for Safe Use



### ⚠ Caution

### 🚫 Instructions

Do not allow children to touch packing material such as styrofoam and vinyl.



- This may cause suffocation.

Prevent children from climbing or hanging on the product.



- This may cause the product to fall down, leading to injury of the children.

Do not connect anything other than the water supply to the Tap Water Supply Pipe.



- Water other than the tap water (drinking water) may cause disease.
- It may cause a malfunction or reduce the lifecycle of the product.

Do not install the product in a place such as below.

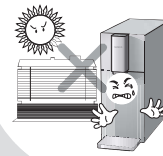

- Outdoors
- A place exposed to direct sunlight
- Near a bathroom
- In front of a cooler or a heater
- On a slope

Do not damage the refrigerant circuit.



- This may cause a malfunction of the product.

Do not repeatedly operate the hot water dispensing and stoppage operations.

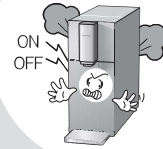

- This may cause a malfunction of the product. In particular, steam may occur.

Do not randomly connect an apparatus to reduce pressure to the Hot Water Apparatus Pipe.

- In particular, it may cause steam.

Please take caution when using steam Sterilization(Cleaning).



- During steam Sterilization(Cleaning), make sure that steam does not reach the body. (Extra caution is required for the elderly and children.)
- During steam Sterilization(Cleaning), do not grab or remove the Sterilization(Cleaning) cup. (Regarding how to cancel Sterilization(Cleaning), refer to page 21)

## During Use

This product is exclusively for AC 220V-240V only, and make sure to use an outlet exclusively for 220V-240V that can be grounded.

When you use an extension cord (such as a multi-power outlet), do not simultaneously connect any other product.

Failure to ground may cause electric shock due to a short circuit.

Be sure to only use the product after grounding.

- 1 In the case of an outlet with a grounding terminal  
When there is a grounding terminal, you can immediately use the power outlet without any extra work.
- 2 In the case of an outlet without a grounding terminal  
Check if the earth leakage breaker is installed and, if it is not installed, install one and then use the product. If there is no earth leakage breaker, it may cause a fire.



## Part Names and Accessories

### Part names

<Top Side>

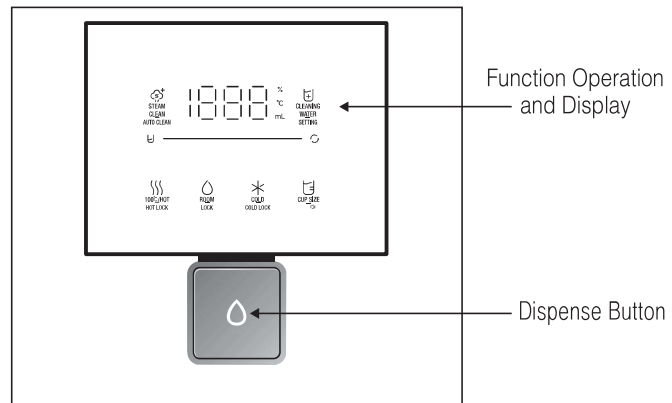

<Front and Back>

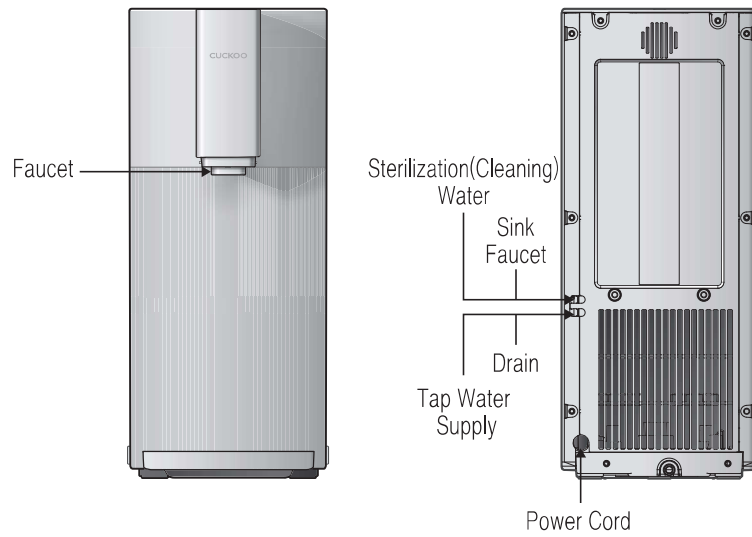

## Part Names and Accessories



### Part names

<Details about Display Panel>

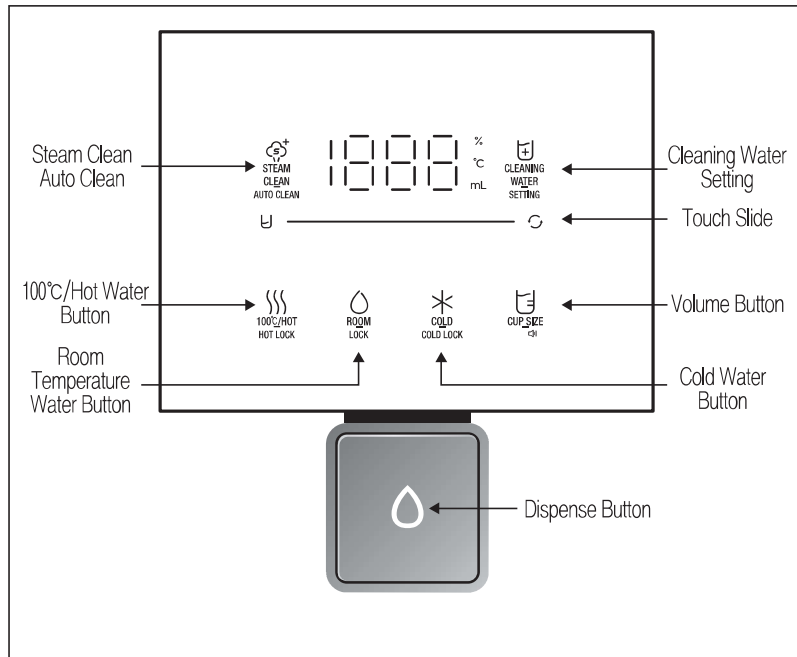

### Accessories



User Manual



Service Card



External Valve  
(Optional)



Sterilization (Cleaning) Cup  
(If it is lost, contact to  
Customer Service Center to  
purchase a new one )

ENG



## Water Purification System

### Water Purification System

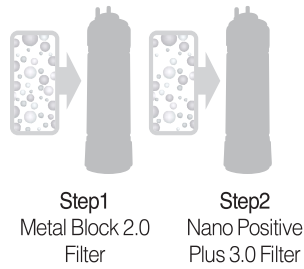

LEVEL	Filter Name	Filter Function
Level 1	Metal Block 2.0 Filter	Absorbs and removes seven heavy metals (mercury, lead, cadmium, arsenic, iron, aluminum, copper), organic chemicals, etc.
Level 2	Nano Positive Plus 3.0 Filter	Absorbs and removes particulates, Escherichia coli, Pseudomonas aeruginosa, Staphylococcus aureus, and norovirus.

※ Using a non-Cuckoo filter or using a genuine Cuckoo filter for an extended period may result in poor filter performance.

## How to Install the Product



### How to Install the Product

incomplete diagram

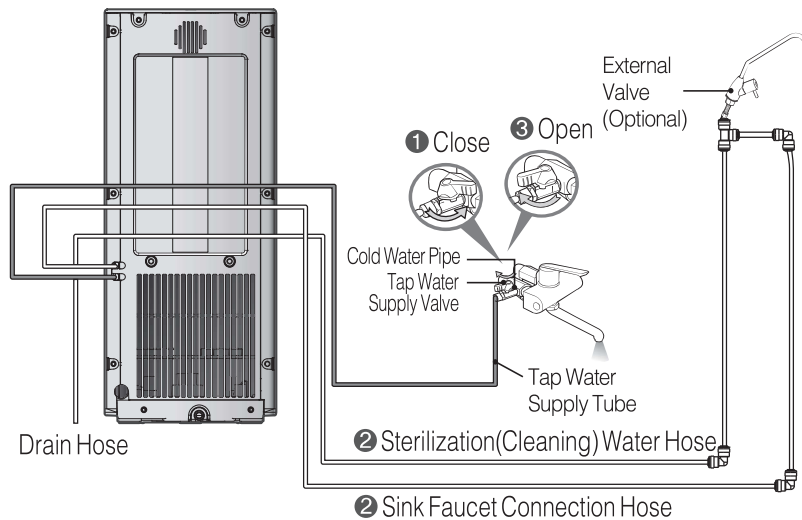

**1** Install the Tap Water Supply Valve and turn it to CLOSE.

- Please make sure that you use tap water from the water supply. Do not use other water sources, such as groundwater.

**2** Connect the Tap Water Supply Hose to the inlet and the Drain Hose to the drain.

- (When installing the sink faucet) Connect the sink faucet connection hose, sink faucet dispensing hose and Sterilization (Cleaning) water hose to the sink faucet connection area.
- Fix the Drain Hose so that water discharged from the hose does not splash to the surroundings.
- Do not place the Drain Hose above the installation surface or connect it to the water purifier over a distance of 3m or greater.
- When connecting the drain hose to the drain while letting the hose touch the floor of the kitchen, etc., do not lift it 30cm or higher from the floor.

**3** Turn the Tap Water Supply Valve to OPEN. **4** Connect the power.

**5** Use the Auto Filter Cleaning function to clean the filter (regarding the Auto Filter Cleaning, refer to Page 24).

After the installation has completed, please check if water leaks from the tube connecting parts.

- Tap Water Supply Valve (Tube)
- Tap Water (Inlet) Hose, Sink Faucet Connection Hose, Drain Hose
- Sink Faucet Dispensing Hose, Sterilization (Cleaning) Water Hose
- Filter Connection Tube

※ In order to guarantee the optimum performance of the product, consult with the technician of our company about the detailed method of installation.

※ The water used for inspection process during production of the product may remain inside the product. Do not worry as it is not a used product.

※ When installing the product, do not reuse the Tap Water Supply Valve and the tubes that were used before.

ENG



## Checklist Before Use

### Checklist Before Use

**1** Open the Tap Water Supply Valve.

- ▶ Open the Tap Water Supply Valve, and check if there is water leak on each connection part.
- Tap Water Supply Valves and water (inlet) and drain of the product

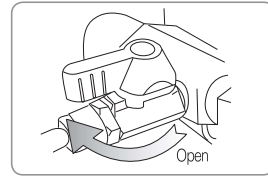

**2** Turn the Close lever of the filter door on the right side of the product to the CLOSE direction.

- Water is supplied to the water purifier.

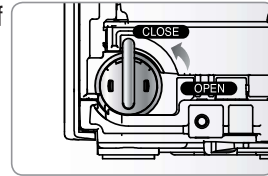

**3** Connect the power.

- ▶ This product is exclusively for 220V-240V .  
Please make sure to plug it into a proper outlet.

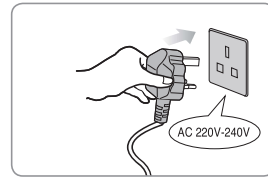

**4** Empty out the tray on a regular basis.

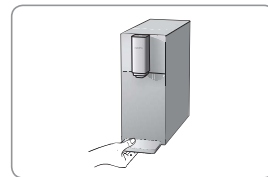

**5** Exchange and manage the filter on a regular basis.

- ▶ Please clean and replace the filters regularly so that you can always enjoy pure and clean water.
- ▶ Regarding the filter replacement cycle, refer to Page 31.

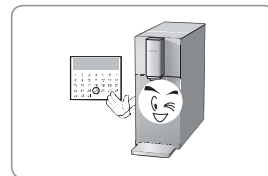

## How To Use



### To Set Functions

#### ① Standby Mode

- ▶ It is the mode in which it waits for cold water, hot water, room temperature water or Sterilization (Cleaning) water to be dispensed. The display panel turns on according to the selected feature and displays the dispensing volume.
- ▶ If the product is idle for 15 seconds, the display panel automatically turns off.
- ▶ If the product detects human presence while the display panel is off, the screen will automatically turn on. (Regarding the use of Hidden Display, refer to page 22)

#### ② User Setting Mode

- ▶ To get into this mode, press the [Cleaning Water/Settings] button for about 3 seconds in the Standby mode.

User Setting Mode	
When pressing [Cup Size] once	Voice Volume Setting Feature
When pressing [Cup Size] twice	Mood Lamp Setting Feature
When pressing [Cup Size] three times	Sterilization(Cleaning) Cycle Setting Feature
When pressing [Cup Size] four times	Filter Cleaning Feature
When pressing [Cup Size] five times	Power Save Time Setting Feature
When pressing [Cup Size] six times	Flow Value Correction Feature
When pressing [Cup Size] seven times	Drain Feature
When pressing [Cup Size] eight times	Filter Replacement Alarm Setting Feature
When pressing [Cup Size] nine times	Sterilization(Cleaning) Kit Module Usage Alarm Setting Feature
When pressing [Cup Size] ten times	Language Setting Function

#### ③ Dispense Fixed Volume

- ▶ Press the [Dispense] button once to dispense a fixed volume of water.
- ▶ Use the [Cup Size] button to select the desired fixed volume.  
(120 ml → 250 ml → 1500 ml → 120 ml)
- ▶ Use the [Touch Slide] button to select the desired fixed volume.  
(Regarding the use of Touch Slide, refer to page 19)



## How To Use

### How to Set Cold Water Function

- 1 If the Cold Water Function is turned off, press the [Cold Water] button for 3 seconds to turn the function on.

- ▶ While the [Cold Water] button is being pressed, the Voice Guide will say: "Selecting Cold Water Function."
- ▶ Once the Cold Water Function is turned on, "ON" is displayed and the Voice Guide will say "Cold Water Function selected."

- 2 If you no longer wish to use cold water while the function is turned on, press the [Cold Water] button for 3 seconds to turn the function off.

- ▶ While the [Cold Water] button is being pressed, the Voice Guide will say "Canceling Cold Water Function."
- ▶ Once the Cold Water Function is turned off, "OFF" is displayed and the Voice Guide will say "Cold Water Function canceled."
- ▶ When the [Cold Water] button is pressed while the function is turned off, the Voice Guide will say "Cold Water Function off. Please turn on cold water function before use."

- ※ It is possible to dispense cold water in a stable manner about 1 hour after the Cold Water Function is turned on.
- ※ The function is initially set to be ON on the product.

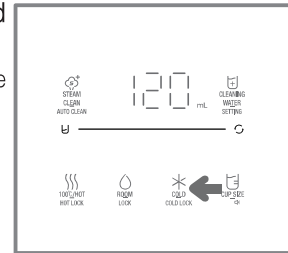

### How To Dispense Cold Water

- 1 Press the [Cold Water] button and select Cold Water

- ▶ The Voice Guide will say "Cold Water."

- 2 How to Dispense Fixed Quantity

- ▶ Press the [Cup Size] button to select the desired dispensing quantity.
- ▶ Press the [Dispense] button once. Cold water will be dispensed
- ▶ When the selected quantity of water is dispensed, the water dispensing will end.
- ▶ If you press the [Dispense] button or any other button while the product is dispensing a fixed quantity of water, the water dispensing will end.

- 3 When dispensing cold water, the dispensing outlet is illuminated.  
(When the Mood function is turned OFF, the lamp will not be turned ON.)

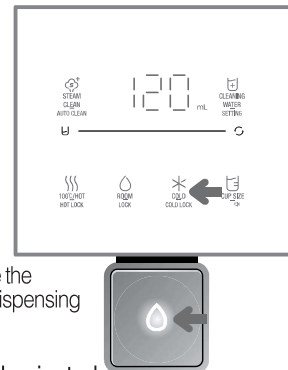



## How To Use



### How To Use Room Temperature Water

- 1 Press the [Room Temperature Water] button to select room temperature water.
  - ▶ The Voice Guide will say "Room Temperature Water."

- 2 How to Dispense Fixed Quantity

- ▶ Press the [Cup Size] button to select the desired dispensing quantity.
- ▶ Press the [Dispense] button once.  
The room Temperature Water will be dispensed
- ▶ When the selected quantity of water is dispensed, the water dispensing will end.
- ▶ If you press the [Dispense] button or any other button while the product is dispensing a fixed quantity of water, the water dispensing will end.



- 3 When dispensing room temperature water, the dispensing outlet is illuminated.  
(When the Mood function is turned OFF, the Lamp will not be turned ON.)

### How to Set Child Lock

This is the function that prevents random control by children, etc. and protects them against burns. Once the function is set, the [Hot Water] button will not work.

- 1 Press the [Hot Water] button for about 3 seconds in Standby Mode to set the Child Lock.

- ▶ If the [Hot Water] button is pressed in the Child Lock state, "Loc\_" is displayed and the Voice Guide will say "Child lock on".
- ▶ If the [Hot Water] button is pressed for about 3 seconds during the Child Lock, "Un\_Loc\_" is displayed and the Child Lock will be canceled.



ENG



## How To Use

### How to Use Hot Water (typical hot water temperature of 100°C)

- 1 Press the [Hot Water] button and select Hot Water.
  - ▶ The Voice Guide will say "Hot Water."
- 2 How to Dispense Fixed Quantity
  - ▶ Press the [Cup Size] button to select the desired dispensing quantity.
  - ▶ Press the [Dispense] button once. After preheating, the hot water will be dispensed.
  - ▶ When the selected quantity of water is dispensed, the water dispensing will end.
  - ▶ If you press the [Dispense] button or any other button while the product is dispensing the fixed quantity of water, the water dispensing will end.
- 3 When dispensing hot water, the dispensing outlet is illuminated.  
(When the Mood function is turned OFF, the lamp will not be turned ON.)
  - ※ There is a risk of burns due to spattering of water. Thus, please put the cup near the faucet.
  - ▶ Press the [Dispense] button. Hot water will be dispensed.
  - ▶ If you keep pressing the [Dispense] button for two seconds or longer, the product will be changed to the Manual Dispensing status.
  - ▶ The Voice Guide will say "Water dispensing during pressing".
  - ▶ If you stop pressing the [Dispense] button during the Manual Dispensing, the water dispensing will end.
- 4 The temperature may differ depending on the surroundings and service conditions.



### How to Use Hot Water Temperature Function (Custom Hot Water)

- 1 How to Use the Hot Water Temperature Feature
  - ▶ Every time the [Hot Water] button is pressed, the temperature changes. The [Hot Water] button is illuminated in different colors with every change.
  - ▶ Select the [Hot Temp.] and press the [Dispense] button to dispense hot water at the selected temperature.
  - ▶ If you press the [Dispense] button or any other button while the product is dispensing hot water, the water dispensing will end.



### How to Dispense the Fixed Volume of Water

- 1 Every time the [Volume] button is pressed, the fixed volume changes.
  - ▶ 120 ml → 250 ml → 1500 ml → 120 ml
- 2 After selecting the desired fixed volume, press the [Dispense] button to dispense water at the selected volume.

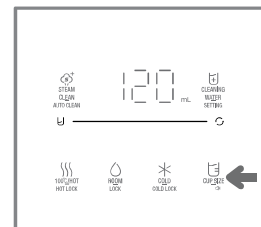

## How To Use



### How to Change the Dispensing Volume Using the Touch Slide

- ① Drag the Touch Slide area (marked with the arrow) in the center to change the dispensing volume.
- ② After selecting the desired volume, press the [Dispense] button to dispense water at the selected volume.
  - ▶ Using Touch Slide, the dispensing volume changes in 9 steps.

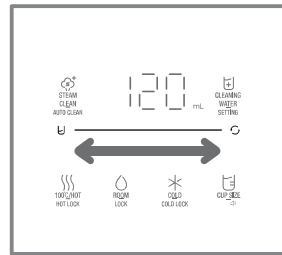

120mL 200mL 250mL 350mL 500mL 550mL 850mL 1000mL 1500mL

※ The dispensing volume will not change if you press areas other than one marked with the arrow.



### How to Use Sterilization(Cleaning) Water (when installing a sink faucet valve)

- ① Click the [Cleaning Water] button and select Sterilization(Cleaning) water.
  - ▶ Once the [Cleaning Water] button is pressed, the [Cleaning Water] button display lamp is turned on.
  - ▶ The Voice Guide will say "Sterilization function set."
  - ▶ Once the sink faucet lever is opened, Sterilization (Cleaning) water is dispensed.
- ② How to end the dispensing of Sterilization(Cleaning) water
  - ▶ Once the [Cleaning Water] button is pressed, the [Cleaning Water] button display lamp is turned off.
  - ▶ The Voice Guide will say "Sterilization water function cancelled".
  - ▶ Close the sink faucet lever.
  - ▶ The Voice Guide will say "Start sink faucet line Cleaning."
  - ▶ After Sterilization(Cleaning) is complete, the Voice Guide will say "Sink faucet line Cleaning completed".

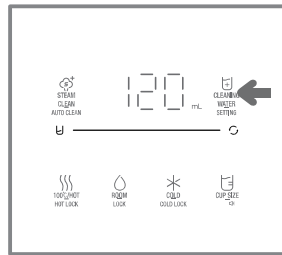

※ How to correctly cleanse fruits and vegetables

- ▶ Remove dirt and other foreign substances prior to Sterilization(Cleaning), and immerse in Sterilization(Cleaning) water for about 5 minutes.
- ▶ After Sterilization(Cleaning), wash with clean water for over 3 times so that the Sterilization(Cleaning) water is completely removed.

※ Sterilization(Cleaning) water is not for drinking. Prevent anyone from drinking the Sterilization(Cleaning) water. (CUCKOO Sterilization(Cleaning) water is being managed within the standard scope of the "Drinking Water Management Act" so do not worry about using it but try to avoid drinking it.)

※ The sink faucet lever can be controlled to increase the concentration of the Sterilization(Cleaning) water.



## How To Use

### How to Use Auto Sterilization(Cleaning) Reservation Function

① If the [Steam/Auto Clean] button display lamp is turned on in Standby Mode, the Auto Sterilization (Cleaning) Reservation function is set as Use.

② While the [Steam/Auto Clean] button display lamp is turned off, press the [Steam/Auto Clean] button.

- ▶ The Voice Guide will say "Auto sterilization Set-up Completed".
- ▶ The [Steam/Auto Clean] Button Display Lamp will be turned ON.

③ To cancel the Auto Sterilization(Cleaning) Reservation, press the [Steam/Auto Clean] button while the function is turned on.

- ▶ The Voice Guide will say "Auto Sterilization reservation Canceled".
- ▶ The [Steam/Auto Clean] button display lamp is turned off.

※ While auto Sterilization(Cleaning) is in progress, do not dispense water through the sink faucet.

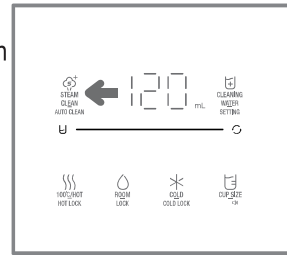

### How to Move Faucet

<Move up and down>

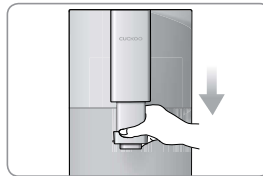

※ **Caution**

Be careful as repeated use for a long period of time may heat up the outlet.

<Move front and back>

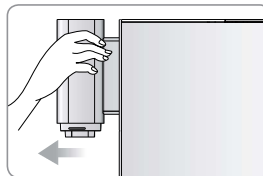
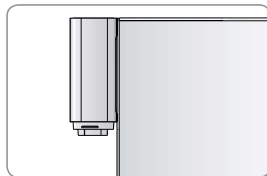

## How To Use



### How To Use the Immediate Auto Sterilization(Cleaning) Function

This feature is used to start auto Sterilization(Cleaning) at the time of your choice.

- ▶ The method and duration of Sterilization(Cleaning) are identical to Reserved Sterilization(Cleaning).
- 1 Press the [Steam/Auto Clean] button for about 3 seconds in Standby Mode.
    - ▶ Once the Immediate Auto Sterilization(Cleaning) begins, the Voice Guide will say "Start flow path Sterilization(Cleaning)."
    - ▶ The [Steam/Auto Clean] button display lamp is turned on and the progress of Sterilization(Cleaning) is displayed.
      - The progress is shown on the display panel in %.
  - 2 To cancel the Sterilization(Cleaning) operation, press the [Steam/Auto Clean] button during an Auto Sterilization(Cleaning) operation.
    - ▶ The Voice Guide will say "Flow path Sterilization canceled.", and the Sterilization(Cleaning) cancellation operation proceeds
    - ▶ Depending on the situation, it proceeds to follow-up processes such as Sterilization(Cleaning) water drainage, rinsing and input, and a certain period of time is taken until it reaches the Standby Mode in which intake is possible.



※ While auto Sterilization(Cleaning) is in progress, do not dispense water through the sink faucet.

### How to Use Immediate Faucet Sterilization(Cleaning) and Steam Sterilization(Cleaning)

- 1 Place the **Sterilization(Cleaning) cup**.
  - ▶ Before placing the cup, put the faucet unit back in place. When the faucet and Sterilization(Cleaning) cup are not in place, the Sterilization(Cleaning) cup may not be detected.
- 2 In the Standby mode, press the [Steam/Auto Clean] button to select.
  - ▶ When pressing the [Steam/Auto Clean] button once  
- Electrolysis faucet Sterilization(Cleaning) starts, and the Voice Guide will say, "Start faucet Sterilization."
  - ▶ When pressing the [Steam/Auto Clean] button for about 3 seconds  
- Steam Sterilization(Cleaning) starts, and the Voice Guide will say, "Start steam Sterilization."
  - ▶ The [Steam/Auto Clean] button display lamp is turned on, and the progress is shown on the display panel in %.
- 3 To cancel the Sterilization(Cleaning) operation, press the [Steam/Auto Clean] button during the Faucet Sterilization(Cleaning) operation
  - ▶ The Voice Guide will say "Steam or Faucet Sterilization(Cleaning) canceled", and the Sterilization(Cleaning) cancellation operation proceeds.
  - ▶ When canceling Faucet Sterilization(Cleaning), water is dispensed to the faucet to clean the area so do not remove the cup.
    - ※ Please remove the Sterilization(Cleaning) cup after the operation is completed.



※ Sterilization(Cleaning) water is not for drinking. Prevent anyone from drinking the Sterilization(Cleaning) water.  
※ You may use steam Sterilization(Cleaning) once a day.  
※ Be careful of burns, as steam Sterilization(Cleaning) can be hot.  
※ Water droplets may form on the front of the product after steam Sterilization(Cleaning).  
※ Put the rubber packing of the Sterilization(Cleaning) cup to wrap the faucet without being pressed. Or the Sterilization(Cleaning) cup may not be detected.



## How To Use

### How to Use the Hidden Display Feature

This feature is used to save power with the display panel turned off and the brightness of the display lamps reduced.

#### ① How to enter the Hidden Display mode

- ▶ After 15 seconds of no button input and no detection of human presence in the Standby mode
- ▶ You can cancel Hidden Display and change the time set for entering the mode in the User Setting mode. (Refer to "Power Save Time" on page 25)

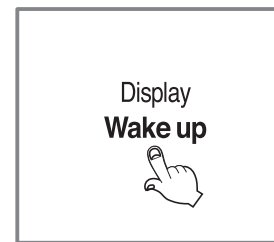

#### ② How to get out of the Hidden Display mode

- ▶ When human presence is detected in Hidden Display mode
- ▶ When button is pressed in Hidden Display mode
- ※ When pressing the [Dispense] button in the Hidden Display mode, the water is immediately dispensed.
- ※ When you approach the product from the front, the human detection sensor operates. (The sensor sensitivity may vary depending on the installed environment.)



### How to Use the Full Lock Feature

This feature is used to prevent random control by children, etc., or to clean the product. If this feature is enabled, the inputs of all the buttons are blocked.

#### ① If you press the [Room Temperature Water/Full Lock] button for about 3 seconds, the Full Lock will be turned on.

- ▶ If a button is pressed in Full Lock, "Loc" is displayed, and the Voice Guide will say, "Full lock enabled."
- ▶ If the [Room Temperature Water/Full Lock] button is pressed for about 3 seconds in Full Lock, "Un\_Loc" is displayed, and the Full Lock will be turned off.

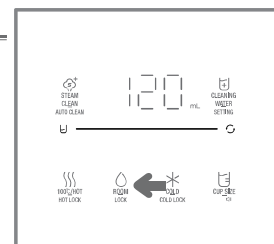

### How to Use the Voice Guide Feature

This feature is used to turn the Voice Guide on and off.

#### ① How to disable the Voice Guide Feature

- ▶ Press the [Cup Size/Voice] button for about 3 seconds in the Standby mode to disable the Voice Guide feature.

#### ② How to Use the Voice Guide Feature

- ▶ Press the [Cup Size/Voice] button for about 3 seconds in the Standby mode to enable the Voice Guide feature.

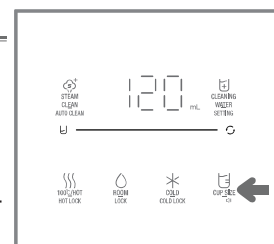

## How To Use



### How to Change Voice Volume

- 1 Press the [Cleaning Water/Setting] button for 3 seconds in Standby Mode.
  - ▶ The product will enter the User Setting mode.
- 2 After entering the User Setting Mode, press the [Cup Size] button once.
  - ▶ The Voice Guide will say "Voice volume setting mode".
- 3 Press the [Cleaning Water/Setting] button to enter the Voice Volume Setting Mode.
- 4 Press the [Cold Water] button to set the voice volume level.
  - ▶ Each time you press the button, the step will be changed by one step from the previously set voice level.  
e.g.) Level 4 → Level 5 → OF\_1 → OF\_2 → Level 1 → Level 2 → Level 3
  - ▶ In order to set the maximum volume, select the set value to be 5.
  - ▶ If the Voice Guide is not used, select so that the setting value is OF\_1.
- 5 After selecting the desired voice volume, press the [Cleaning Water/Setting] button to save it.
  - ▶ The Voice Guide will say "Set-up completed".

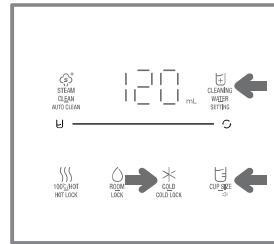

### How To Use the Mood Lamp function

- 1 Press the [Cleaning Water/Setting] button for 3 seconds in Standby Mode.
  - ▶ The product will enter the User Setting mode
- 2 After entering the User Setting Mode, press the [Cup Size] button twice.
  - ▶ The Voice Guide will say "Mood lamp setting mode".
- 3 Press the [Cleaning Water/Setting] button to enter the Mood Lamp Setting Mode.
- 4 Press the [Cold Water] button to set the Mood Lamp function.
  - ▶ Every time the button is pressed, the mood lamp setting is adjusted.  
e.g.) ON3 (maximum brightness) → OFF → ON1 (minimum brightness) → ON2 → ...
- 5 After selecting the mood lamp feature, press the [Cleaning Water/Setting] button to save it.
  - ▶ The Voice Guide will say "Set-up completed".

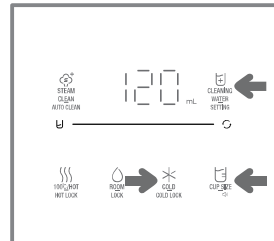



## How To Use

### How to Change Preset Auto Sterilization(Cleaning) Cycle

- 1 Press the [Cleaning Water/Setting] button for 3 seconds in Standby Mode.
  - ▶ The product will enter the User Setting mode.
- 2 After entering the User Setting Mode, press the [Cup Size] button three times.
  - ▶ The Voice Guide will say "Sterilization Cycle Setting Mode".
- 3 Press the [Cleaning Water/Setting] button to enter the Sterilization(Cleaning) Cycle Setting Mode.
- 4 Each time you press the button, the step will be changed by one step from the previously set Sterilization(Cleaning) cycle.
  - ▶ Press the [Cold Water] button to set the Cleaning cycle.  
e.g.) 6 days → 7 days → 8 days → 9 days → 10 days → 3 days → 4 days → 5 days
- 5 After selecting the Sterilization(Cleaning) cycle, press the [Cleaning Water/Setting] button to save it.
  - ▶ The Voice Guide will say "Set-up completed".



### How to Use Auto Filter Cleaning Function

- 1 Press the [Cleaning Water/Setting] button for 3 seconds in Standby Mode.
  - ▶ The product will enter the User Setting mode.
  - ▶ After entering the User Setting mode, press the [Cup Size] button four times.
  - ▶ The Voice Guide will say, "Automatic filter flushing function."
- 2 Press the [Cleaning Water/Setting] button.
  - ▶ The Voice Guide will say "Start auto filter cleaning", and the filter is automatically cleaned.
  - ▶ The progress is shown on the display panel in %.
- 3 Once the Auto Filter Cleaning is completed, the Voice Guide will say "Auto filter cleaning completed" and it enters the Standby Mode in which dispensing is possible.
- 4 To cancel the Auto Filter Cleaning function, press the [Cleaning Water/Setting] button during the Auto Filter Cleaning.
  - ▶ The Voice Guide will say "Auto filter cleaning stopped".
- 5 The time it takes for the Auto Filter Cleaning may vary depending on the water pressure of the water source, and it takes about 10 to 15 minutes.
  - ▶ When the Voice Guide says, "Check the tap water intake" while the filter is being cleaned, open the filter door cover on the front of the product and turn the lock lever to the CLOSE direction.





## How To Use



### How to Change the Power Save Time

- 1 Press the [Cleaning Water/Setting] button for 3 seconds in Standby Mode.
  - ▶ Enter User Setting mode.
- 2 After entering the User Setting Mode, press the [Cup Size] button 5 times.
  - ▶ The Voice Guide will say, "Power Save Time Setting Mode."
- 3 Press the [Cleaning Water/Setting] button to enter the Power Save Time Setting mode.
- 4 Press the [Cold Water] button to set the power save time.
  - ▶ Every time the button is pressed, the power save time changes.  
e.g.) 30 seconds → 60 seconds → ON (screen stays on) → 15 seconds (screen turns off after 15 seconds)
- 5 After selecting the power save time, press the [Cleaning Water/Setting] button to save it.
  - ▶ The Voice Guide will say, "Set-up completed."



ENG

### How to Change Dispensing Volume

- 1 Press the [Cleaning Water/Setting] button for 3 seconds in Standby Mode.
  - ▶ The product will enter the User Setting mode.
- 2 After entering the User Setting Mode, press the [Cup Size] button six times.
  - ▶ The Voice Guide will say, "Flow Correction Value Setting Mode."
- 3 Press the [Cleaning Water/Setting] button to enter the Flow Correction Value Setting mode.
- 4 Press the [Cold Water] button to set the flow correction value.
  - ▶ Every time the button is pressed, the flow correction value changes.  
e.g.) 5% (dispensing volume increased) → 10% → -10% → -5% (dispensing volume decreased) → 0%
- 5 After selecting the flow correction value, press the [Cleaning Water/Setting] button to save it.
  - ▶ The Voice Guide will say "Set-up completed".

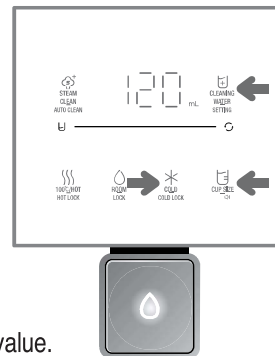



## How To Use

### To drain the refrigerant water

- 1 Press the [Cleaning Water/Setting] button for 3 seconds in Standby Mode.
  - ▶ The product will enter the User Setting mode.
- 2 After entering the User Setting Mode, press the [Cup Size] button seven times.
  - ▶ The Voice Guide will say, "Start Draining."
- 3 Press the [Cleaning Water/Setting] to enter the Refrigerant Water Drain feature.
- 4 When entering the Refrigerant Water Drain mode, the refrigerant water is automatically drained.



### How to Use Filter Replacement Alarm Feature

- 1 Press the [Cleaning Water/Setting] button for 3 seconds in Standby Mode.
  - ▶ The product will enter the User Setting mode.
- 2 After entering the User Setting Mode, press the [Cup Size] button eight times.
  - ▶ The Voice Guide will say, "Filter Replacement Alarm Setting Mode."
- 3 Press the [Cleaning Water/Setting] button to enter the Filter Replacement Alarm Setting Mode.
- 4 Press the [Cold Water] button to set the Filter Replacement Alarm Setting Mode.
  - ▶ It repeats ON/OFF every time the button is pressed.  
e.g.) ON → OFF → ON → OFF → ...
- 5 After selecting the Filter Replacement Alarm ON/OFF, press the [Cleaning Water/Setting] button to save it.
  - ▶ The Voice Guide will say "Set-up completed".
  - ※ When the function is turned off, the filter replacement alarm will not sound.

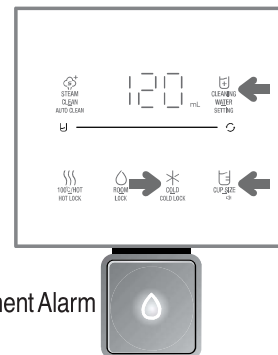

## How To Use



### How to set the Sterilization(Cleaning) Module Usage Alarm function

- 1 Press the [Cleaning Water/Setting] button for 3 seconds in Standby Mode.
  - ▶ The product will enter the User Setting mode.
- 2 After entering the User Setting Mode, press the [Cup Size] button nine times.
  - ▶ The Voice Guide will say, "Sterilization kit module usage alarm Mode."
- 3 Press the [Cleaning Water/Setting] button to enter the Sterilization(Cleaning) Module Usage Alarm Setting Mode.
- 4 Press the [Cold Water] button to set the Sterilization Module Usage Alarm function.
  - ▶ It repeats ON/OFF every time the button is pressed.  
e.g.) ON → OFF → ON → OFF → ...
- 5 After selecting the Sterilization Module Usage Alarm ON/OFF, press the [Cleaning Water/Setting] button to save it.
  - ▶ The Voice Guide will say "Set-up completed".
  - ※ When the function is turned off, the Sterilization module usage alarm is not sounded.



### How to set Language

- 1 Press the [Cleaning Water/Setting] button for 3 seconds in Standby Mode.
  - ▶ The product will enter the User Setting mode.
- 2 After entering the User Setting Mode, press the [Cup Size] button ten times.
  - ▶ The Voice Guide will say, "Voice selection mode."
- 3 Press the [Cleaning Water/Setting] button to enter the Language Setting mode Mode.
- 4 Show current language.
  - ▶ Please change language setting by pressing the blinking button, then, press the set-up button.
- 5 Press the [Cold Water] button to select a language.
  - ▶ Each time you press the button, the language will change.  
e.g) 1(English) → 2(Cantonese) → 3(Mandarin) → ...
- 6 Select the desired language and save it by pressing the [Cleaning Water/Setting] button.
  - ▶ The Voice Guide will say "Set-up completed."



ENG



## How To Clean Tray / How To Clean Main Body

### How to Clean the Tray

#### ① Detach the Tray

- ▶ Hold and pull the tray towards the front side of the product to separate it from the product.

※ When you pull the tray, pull it slowly with both hands. If you strongly pull it, the water may pour out.

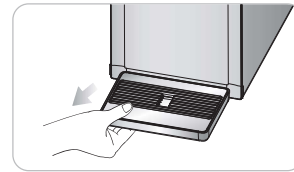

#### ② Detach the Tray Grille

- ▶ Then detach the Tray Grille from the tray by taking hold of and uplifting the hole at the Grille.

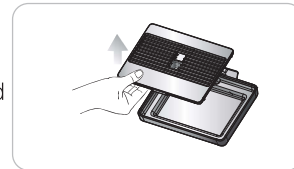

#### ③ Clean the Tray

- ▶ Dispose of the stagnant water, and completely wipe it out with a soft cloth.



#### ④ Assemble the Tray

- ▶ After cleaning the tray, place it back in reserve order.

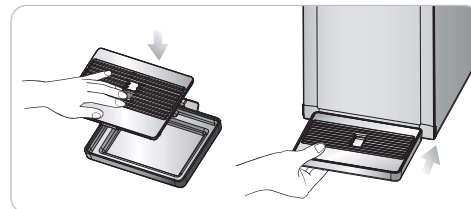

### How to Clean Main Body

- ▶ Wipe with a soft dry cloth.

- Before cleaning, set the Button Lock function to prevent an incorrect operation during cleaning.
- If the product becomes severely polluted, wipe it out with a cloth with a little moisture. (Do not clean the product by using benzene, thinner, or abrasive.)

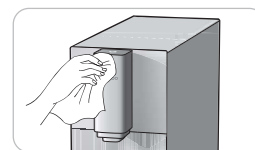

- ▶ Pull the pre-filter on the bottom surface of the product to detach it before washing it with water, drying and re-assembling it.

- If it is not cleaned for a long time, the cool water performance may be lowered.

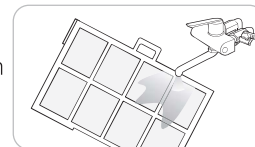

## How To Replace the Filters



### How To Replace the Filters (Must not use non-CUCKOO Water Purifier filters.)

※ The filter door detection sensor is in operation so, when replacing the filter, do not pull the power cord.

- ① Detach the water tray.

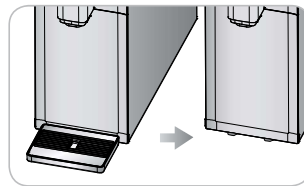

- ② Detach the filter door.

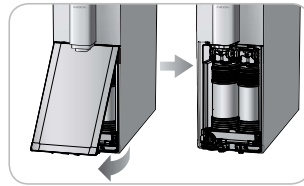

- ③ Turn the filter guide bracket lock lever on the front of the product to the OPEN direction, as shown in the image.

· It shuts off the water supply to prevent water from flowing during filter replacement.

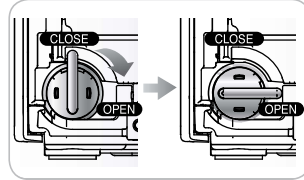

- ④ As shown in the image, pull the filter guide bracket down.

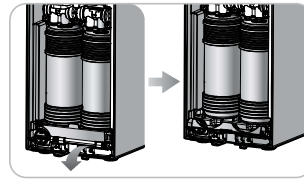

- ⑤ Lift and pull the filter to remove it.

· While the Voice Guide plays, any pressure remaining inside the pipe is removed.  
· During filter replacement, water drops may fall depending on the user environment. Please wipe out any water after replacement.

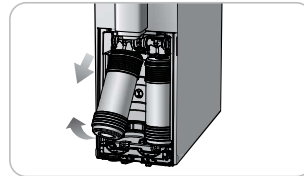



## How To Replace the Filters

### *How To Replace the Filters (Must not use non-CUCKOO Water Purifier filters.)*

※ The filter door detection sensor is in operation so, when replacing the filter, do not pull the power cord.

- ⑥ Insert the filter as shown in the image and push it into the filter case to connect.

- The order of the filters is Metal Block 2.0 and Nano Positive Plus 3.0, from the left.
- Please be mindful of the order.
- Check if the filters are properly installed in the filter case.

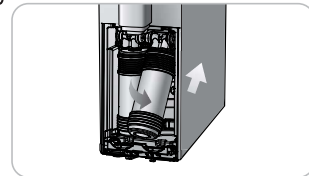

- ⑦ As shown in the image, pull the filter guide bracket up.

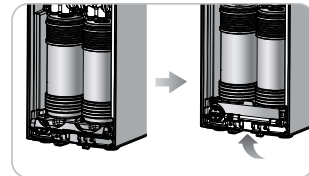

- ⑧ Turn the filter guide bracket lock lever on the front of the product to the CLOSE direction, as shown in the image.

- Water is supplied to the water purifier.

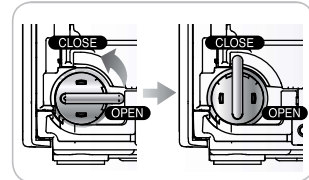

- ⑨ Lock the filter door as shown in the image.

- The groove at the top must be accurately aligned for smooth installation.

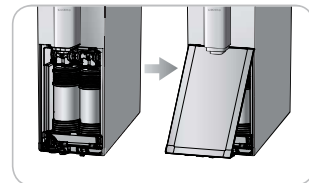

- ⑩ Assemble the water tray.

- ⑪ Once the product enters the Standby mode, use the Auto Filter Cleaning feature to clean the filter.

(Regarding the Auto Filter Cleaning feature, refer to page 24.)

※ When the Voice Guide says, "Check the tap water intake," while the filter is cleaned, turn the lock lever of the filter door on the front of the product to the CLOSE direction.

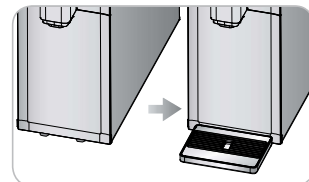

## Expected Filter Replacement Cycle / Recommendations / Filter Arrangement



### Expected Filter Replacement Cycle

- ▶ The filter replacement cycle is determined based on usage of 10L per day in a common household, and may be affected by the state of the source water.

Filter Name	Expected Replacement Cycle
Metal Block 2.0 Filter	4 months
Nano Positive Plus 3.0 Filter	8 months

### Recommendations

- ▶ Filter Replacement Cycle

· Filter replacement cycle refers to a period during which a filter is expected to demonstrate its inherent performance as a result of a thorough review of the filter.

This is based on tap water where the inflow water and daily usage amount is about 10L (drinking water for 4 persons) so, if the amount of usage is greater than this, the replacement cycle may become shortened.

### Filter Arrangement

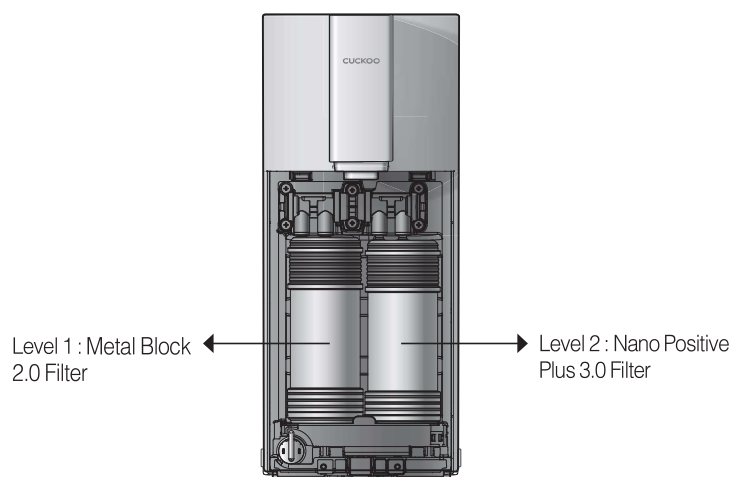

## Please check before asking for Support

▼ If you do not comply with this User Manual, the product may not work properly even if there is no malfunction. Please take the following measures accordingly if there is a problem with the product. If there is still a problem, please contact our Customer Service Center.

Problem	Checklist	Recommended Actions
The water has bad taste and/or odor.	<ul style="list-style-type: none"> <li>• Was the product left idle for a long time?</li> <li>• Do you need to replace the filters?</li> </ul>	<ul style="list-style-type: none"> <li>• Operate the Filter Cleaning function. (Refer to page 24)</li> <li>• Contact Customer Service for filter replacement.</li> </ul>
It fails to dispense water.	<ul style="list-style-type: none"> <li>• Is the Power Cord connected?</li> <li>• Is the tap water supplied properly?</li> <li>• Have you pressed the [Dispense] button properly?</li> <li>• Is there water under the product?</li> <li>• Do you need to replace the filters?</li> <li>• Is the Filter Door lock opened?</li> </ul>	<ul style="list-style-type: none"> <li>• Connect the Power Cord.</li> <li>• Open the Tap Water Supply Valve.</li> <li>• Check if the water supply tube is folded.</li> <li>• Check if water is cut off.</li> <li>• Press the [Dispense] button properly.</li> <li>• Close the Tap Water Supply Valve, unplug the product, and contact our Customer Service Center.</li> <li>• Contact Customer Service for filter replacement.</li> <li>• Close the Filter Door lock on the front of the product. (Water is supplied to the product )</li> </ul>
It fails to dispense cold water.	<ul style="list-style-type: none"> <li>• Have you dispensed a lot of cold water?</li> <li>• Did you close the Tap Water Supply Valve?</li> <li>• Is the ventilation at the back of the product good?</li> </ul>	<ul style="list-style-type: none"> <li>• If a lot of cold water is dispensed, the product needs some time to recool the water.</li> <li>• Check the Tap Water Supply Valve.</li> <li>• Check if the radiator at the back of the product is blocked. Remove any objects blocking the radiator.</li> <li>• Move the product to a place with good ventilation. (Please contact our Customer Service Center whenever you move and reinstall the product.)</li> <li>• If there is excess dust in the air vents, contact our Customer Service Center.</li> </ul>
The hot water is lukewarm.	<ul style="list-style-type: none"> <li>• Is it the first cup of hot water?</li> </ul>	<ul style="list-style-type: none"> <li>• When you first operate the Instantaneous Hot Water function, the temperature of the first cup may be low.</li> <li>• Check if the temperature of the hot water is normal from the second cup.</li> </ul>



## Please check before asking for Support

▼ If you do not comply with this User Manual, the product may not work properly even if there is no malfunction. Please take the following measures accordingly if there is a problem with the product. If there is still a problem, please contact our Customer Service Center.

Problem	Checklist	Recommended Actions
It does not dispense enough water.	<ul style="list-style-type: none"> <li>• Have you closed the Tap Water Supply Valve?</li> <li>• Do you need to replace the filters?</li> <li>• Is the Filter Door lock opened?</li> </ul>	<ul style="list-style-type: none"> <li>• Open the Tap Water Supply Valve.</li> <li>• Replace the Filter with a genuine CUCKOO Filter.</li> <li>• Close the Filter Door lock on the front of the product. (Water is supplied to the product )</li> </ul>
There is a loud noise coming from the product.	<ul style="list-style-type: none"> <li>• Please check if it's installed on firm, even ground.</li> <li>• Does it touch any other objects?</li> <li>• Is the Tray assembled properly?</li> <li>• Are the back surface and the side surfaces of the product in contact with the wall?</li> <li>• Are there items such as a flowerpot, books, or clock on the product?</li> </ul>	<ul style="list-style-type: none"> <li>• Install the product on a flat and solid floor.</li> <li>• Make sure it does not touch any other objects.</li> <li>• If the Tray is not properly mounted, an abnormal noise can be made. Check the state of assembly of the Tray.</li> <li>• Reinstall the product with a proper distance (20 cm) from the wall.</li> <li>• Remove the items on the product.</li> </ul>
There are floating matters in the dispensed water.	<ul style="list-style-type: none"> <li>• Do you need to replace the filters?</li> </ul>	<ul style="list-style-type: none"> <li>• Replace the Filter. (Do not use a Non-Cuckoo filter.)</li> </ul>
There are fine particles in the room water.	<ul style="list-style-type: none"> <li>• Are there bubbles?</li> </ul>	<ul style="list-style-type: none"> <li>• If there are still fine particles in the water after five minutes, immediately contact our Customer Service Center.</li> </ul>
Water is leaking from the purifier.	<ul style="list-style-type: none"> <li>• Is the assembled (connecting) part defective?</li> <li>• Is your home or the external environment humid?</li> </ul>	<ul style="list-style-type: none"> <li>• Close the Tap Water Supply Valve and unplug the product. After that, contact our Customer Service Center for service.</li> <li>• Dew condensation may occur when a cold part of the water purifier meets moisture, which is the same as if a water droplet forms on a water cup.</li> </ul>

ENG

www.cuckoo.hk

## Product Specifications

Product Name		Cuckoo Cold/Hot/Room Temperature Water Purifier
Model Name		CP-ABN100GP (Grace Pink) CP-ABN100GW (Grace White)
Rated Voltage		Single Phase 220-240V~/ 50 Hz
Power Consumption		Cold water 0.6A, Hot water 2400W
Filtration		Electrostatic adsorption filtration system
Filter Category		Metal Block 2.0 Filter      Nano Positive Plus 3.0 Filter
Filter Material		Polypropylene, Compressed Activated Carbon      Polypropylene, Cellulose, Activated Carbon, Compressed Activated Carbon, Polyethersulfone
Filter Replacement Cycle		4 months      8 months
Capacity	Room Temperature Water	Direct water
	Cold Water	Direct water
Climate Class		T (temperate climate)
Product	Weight	Around 11 kg
	Size (WxDxH)	166 mmx 490 mm x 400 mm
Used Tap Water Pressure		0.07-0.69 Mpa (0.7-6.9 bar)
Used Environment Temperature		5-40°C
Used Tap Water Temperature		5-35°C

※ Details indicated in this Instruction Manual (exterior, design, and specifications) may change without notice for quality improvement.

※ Manufacturer: Cuckoo HomeSys Co., Ltd.